

LVF solenoid valve

Home >> Products >> Directional control valve >> Other solenoid valve >> LVF solenoid valve:



Product description:

Other solenoid valve product ----- LVF high quality solenoid valve is introduced into Japanese model. The advantage sare: low power, fine wearable, acute action and long working life.

Ordering Code

LVF3	1	30	- AC220V
Series NO	Coil and Places	Order No	Standard Voltage
LVF3:(Series)	Single-head Double-position	LVF3:30	DC12V
LVF5:(Series)	Double-head Double-position	LVF5:50	DC24V
LVz5:(Series)	Double-head Three-position Close Type	LVz5:20	AC24V 50Hz/60Hz
	Double-head Three-position Exhaust Type		AC110V 50Hz/60Hz
	Double-head Three-position Pressure Type		AC220V 50Hz/60Hz
			AC380V 50Hz/60Hz

Specification

Model	LVF 3130	LVF 3230	LVF 33(4/5)30	LVF 5120	LVF 5220	LVF 53(4/5)20	LVZ 5120	LVZ 5220	LVZ 53(4/5)20
Working Medium	40 Micron Filtered Air								
Motion Pattern	Inner Guide Type								
Joint Pipe Bore	G1/4	G1/8		G3/8			G1/8		
The Position Counting	Two-position	Three-position	Two-position	Three-position	Two-position	Three-position	Two-position	Three-position	Two-position
Effective Sectional Area	Five-way	Five-way	Five-way	Five-way	Five-way	Five-way	Five-way	Five-way	Five-way
	14mm ²	12mm ²	25mm ²	18mm ²	12mm ²	9mm ²			
	(Cv=0.78)	(Cv=0.69)	(Cv=1.39)	(Cv=1.00)	(Cv=0.67)	(Cv=0.50)			
Operating Temperature	5~50°C (41-122°F)								
Working Pressure	0.15~0.8Mpa								
Max. Pressure	1.2Mpa								

Resistance
Power
Consumption AC:4.5VA? DC:3W
Protection
Class IP65(DIN40050)
Insulation F
Wiring Form 出线式或端子式/Lead Wire or Connector Type
Voltage Range $\pm 10\%$
Highest Action
Frequency 每秒 5 次/5 Cycle/Sec
Shortest
Excitation 0.05 秒/0.05 Second
Time

Overall Dimension

TYPE: LVF3130

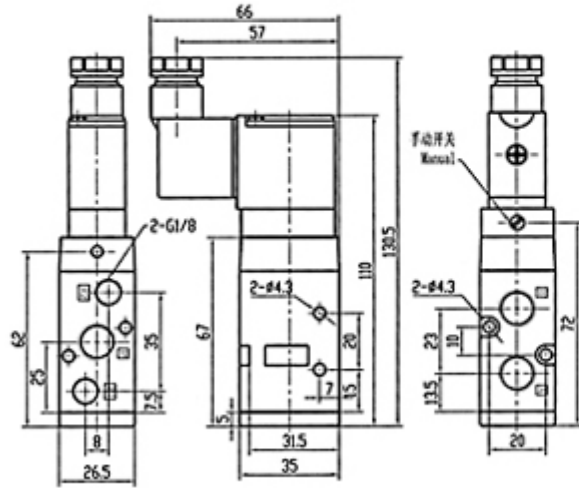

TYPE: LVF3230

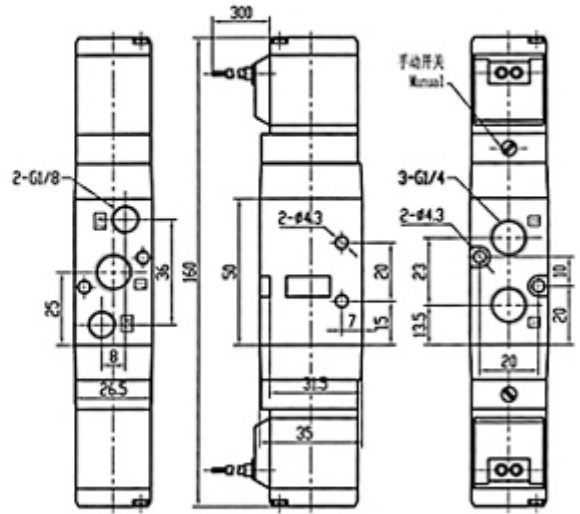

TYPE: LVF5120

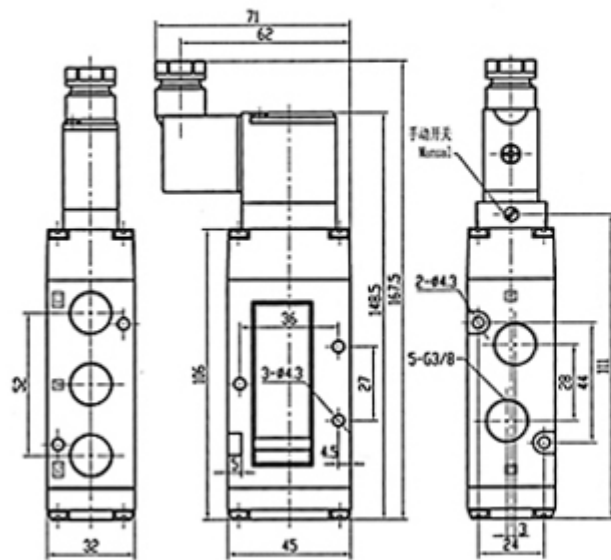

TYPE: LVF5220

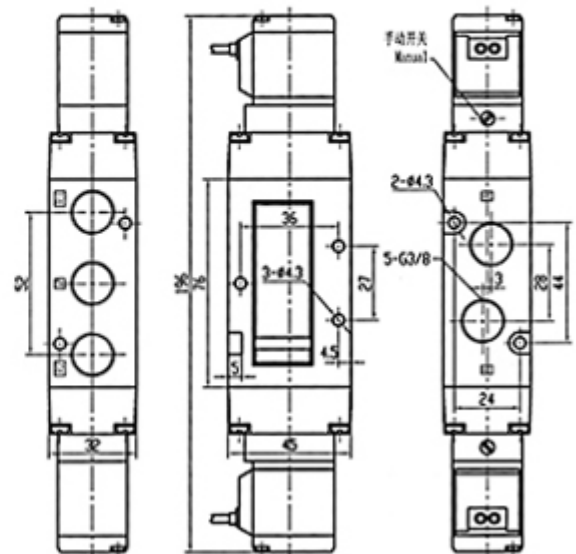

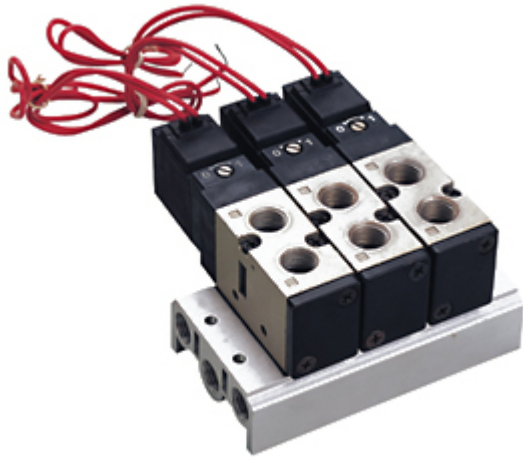

LVF-3000汇流板/Collecting plate

LVF300M

- □F

|
Series Code

|
Joint Base Number

LVF300M:(Series)

LVF300M:Wantonly Joint

LVF500M:(Series)

LVF500M:Wantonly Joint

LVz500M:(Series)

LVZ 500M:Wantonly Joint

Overall Dimension

TYPE: LVF3000M

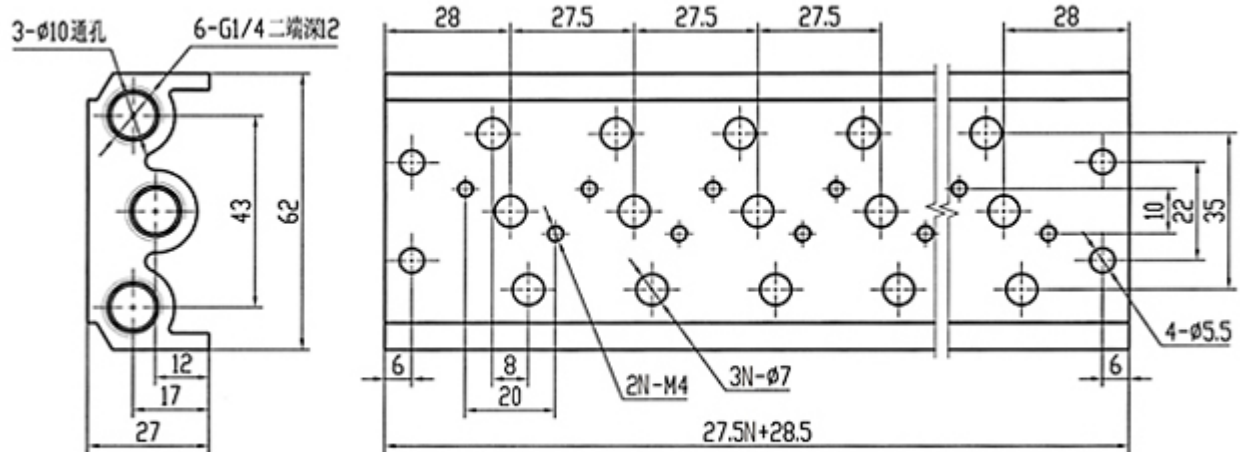

TYPE: LVF5000M

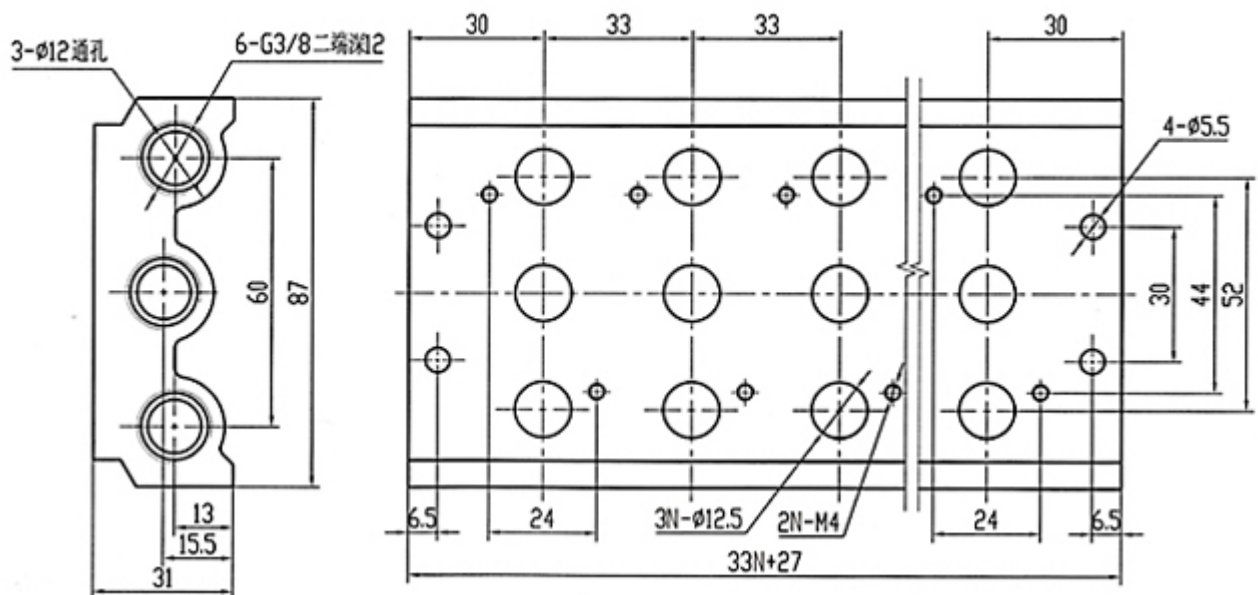

Company Information:

Company Name:

Ningbo Lida Pneumatic Kit Co.,Ltd.

Website:<http://www.cn-lida.com>

Address:

Eighth Quarter, Zhongxing East Road, Xikou, Fenghua, Zhejiang, China.

Post-code:315500

Contact Person:Lacey Liu exporting manager

Phone:

Telephone:0086-574-88846388

Fax:0086-574-88846288

Email:export@nblida.cn