

## LAR regulator

Home >> Products >> Air treatment units >> LAC series air treatment units >> LAR regulator:



### Product description:

LAC series air treatment units product ----- LAR hing regulator is same style as SMC.It is standard regualtor for air treatment units, and also can use with other equipments for regulate the air pressure. We manufacture all important parts by ourself to insure the quality.Outsourcing parts were selected and tested very strictly. The range of adjustable pressure is 0.05~0.85Mpa.

Ordering Code

Graphic symbol

LAR	3000	-	03
Regulator	Specification Code		Joint Pipe Bore
	2000		01:G1/8"
	2500		02:G1/4"
	3000		03:G3/8"
	4000		04:G1/2"
	5000		06:G3/4"
			10:G1"

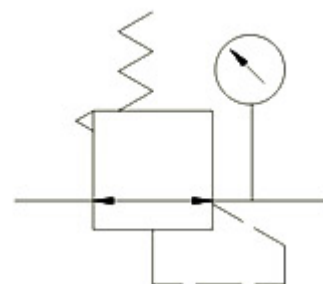

### Specification

Model	LAR2000-01	LAR2000-02	LAR2500-02	LAR2500-03	LAR3000-02	LAR3000-03	LAR4000-03	LAR4000-04	LAR4000-05
Rated Flow	550	550	2000	2000	2500	2500	6000	6000	6000
Joint Pipe Bore	G1/8	G1/4	G1/4	G3/8	G1/4	G3/8	G3/8	G1/2	G3/4
Range of Adjustable Pressure	0.05-0.85MPa								
Max. Adjustable Pressure	1.0MPa								
Ensured Pressure Resistance	1.5MPa								
Operating	5-60°C								

Temperature  
Range

Valve Type

With Overflow

Overall Dimension

TYPE:LAR2000-5000

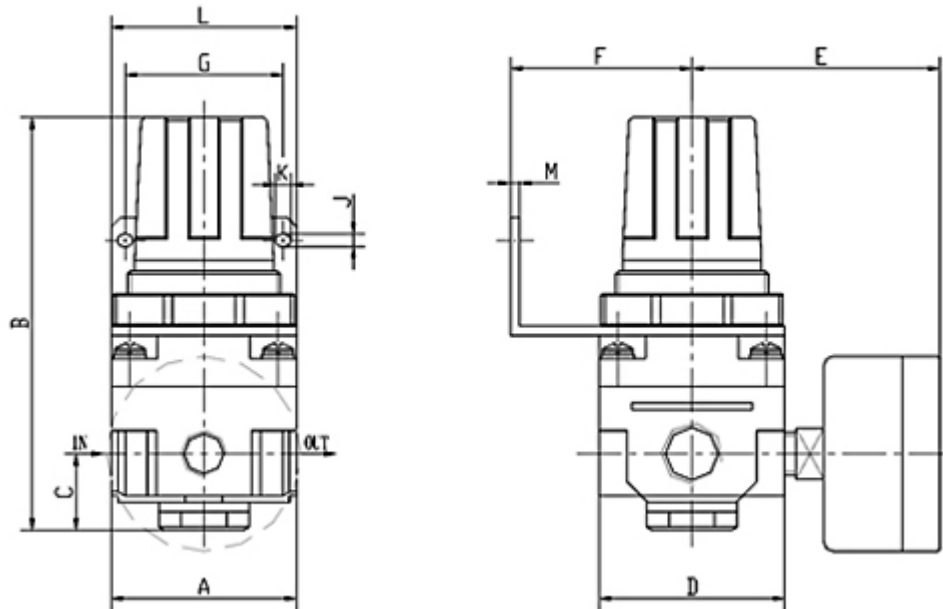

Model	Bore	A	B	C	D	E	F	G	H	J	K	L
LAR2000	1/4	40	95	17	40	56.8	30	34	45	5.4	15.4	55
LAR2500	1/4	53	102.5	25	48	60.8	30	34	44	5.4	15.4	55
LAR3000	1/4-3/8	53	127.5	35	53	60.8	41	40	46	6.5	8.0	53
LAR4000	3/8-1/2	70	149.5	37.5	70	65.5	50	54	54	8.5	10.5	70
LAR4000-06	3/4	75	154.5	40.5	70	69.5	50	54	56	8.5	10.5	70
LAR5000	3/4-1	90	168	48	90	75.5	70	66	65.8	11	13	90

Pressure Character

Supply Pressure=0.7 MPa Secondary Pressure=0.2MPa Flow=20L/min

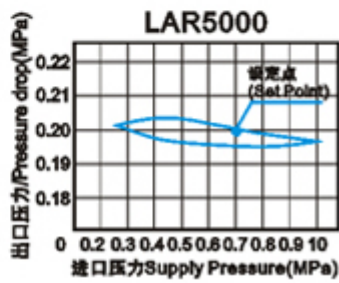
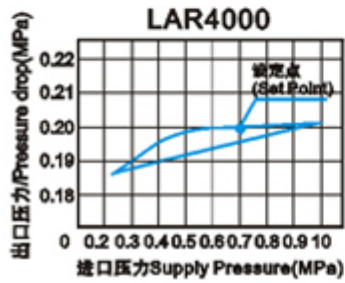
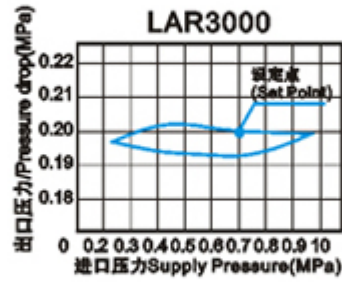
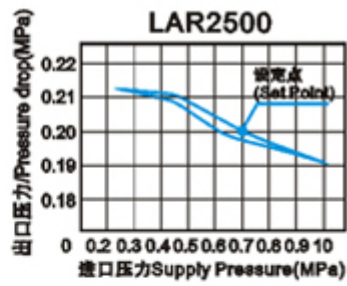
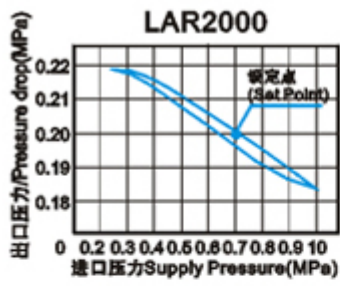

Flowing Character

Supply Pressure=0.7MPa

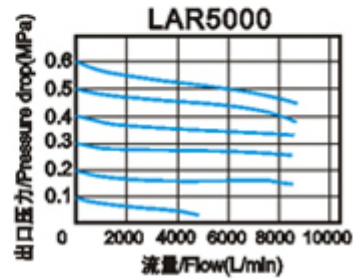
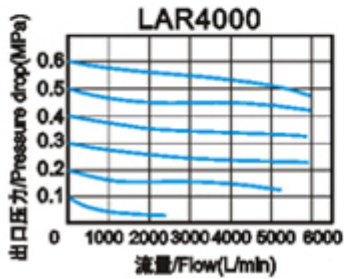
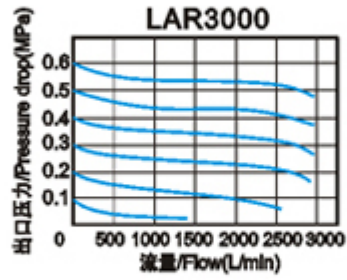
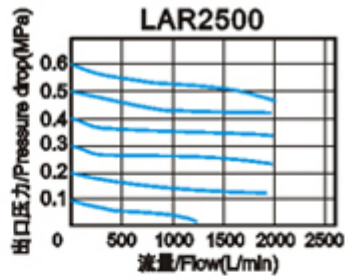
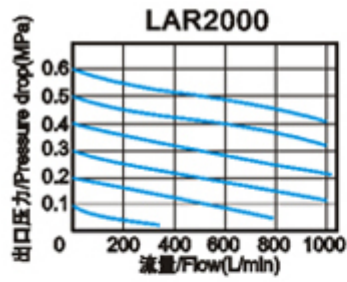

## Company Information:

### Company Name:

Ningbo Lida Pneumatic Kit Co.,Ltd.

Website:<http://www.nblida.cn>

### Address:

Eighth Quarter, Zhongxing East Road, Xikou, Fenghua, Zhejiang, China.

Post-code:315500

Contact Person:Joy Qian exporting manager

### Phone:

Telephone:0086-574-88846388

Fax:0086-574-88846288

Email: [export@nblida.cn](mailto:export@nblida.cn)