

## LAR regulator

Home >> Products >> Air treatment units >> LAC series air treatment units >> LAL lubricator



### Product description:

LAC series air treatment units product ----- LAL air lubricator is same style as SMC. It has excellent performance. It can help valve and cylinder working smoothly. We manufacture all important parts by ourself to insure the quality, such as filter core. Outsourcing parts were selected and tested very strictly. ISO VG32 or equal oil can be applied.

Ordering Code

Graphic symbol

LAL	3000	-	03
Lubricator	Specification		Joint Pipe Bore
	2000		01:G1/8"
	3000		02:G1/4"
	4000		03:G3/8"
	5000		04:G1/2"
			06:G3/4"
			10:G1"

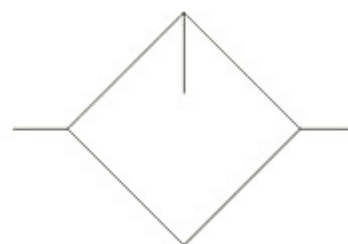

Specification

Model	LAL 2000-01	LAL 2000-02	LAL 3000-02	LAL 3000-03	LAL 4000-03	LAL 4000-04	LAL 4000-06	LAL 5000-06	LAL 5000-10
Rated Flow	800	800	1700	1700	5000	5000	6300	7000	7000
Joint Pipe Bore	G1/8	G1/4	G1/4	G3/8	G3/8	G1/2	G3/4	G3/4	G1
Max. Adjustable Pressure	1.0MPa								
Ensured Pressure Resistance	1.5MPa								
Operating Temperature Range	5-60°C								
Recommended	ISO VG 32								

Oil Use		
Container Material	Polycarbonate	
Protective Cover	Not Available	Available
Overall Dimension		

TYPE:LAL2000

TYPE:LAL3000-4000

TYPE:LAR5000-6000

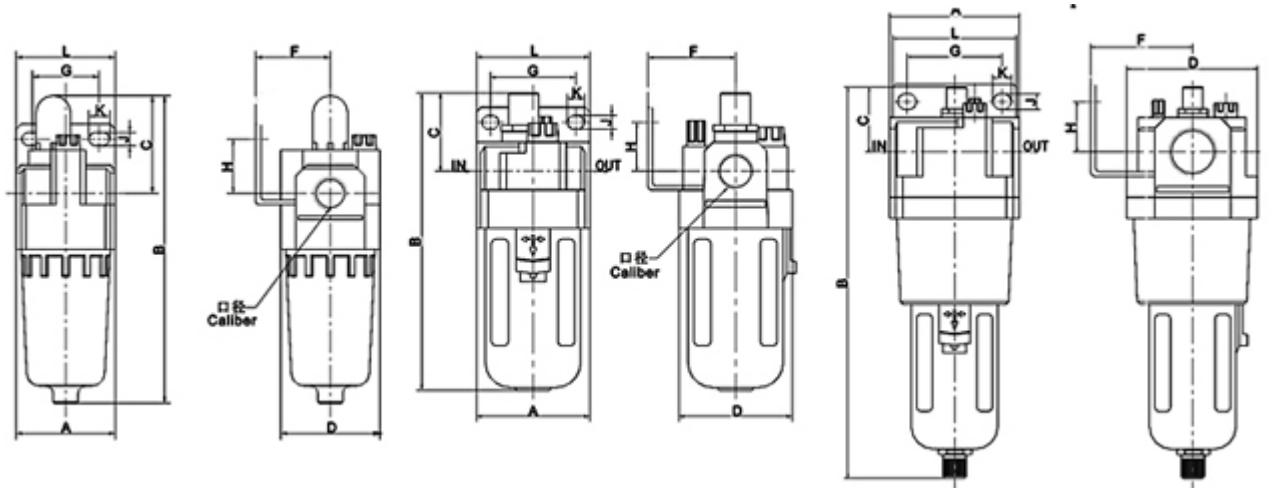

Model	Bore	A	B	C	D	F	G	H	J	K	L
LAL2000	1/4	40	122	38	40	30	27	22	5.4	8.4	40
LAL3000	1/4-3/8	53	142	38	53	41	40	23	6.5	8.0	53
LAL4000	3/8-1/2	70	177	41	70	50	54	26	8.5	10.5	70
LAL4000-06	3/4	75	177	39	70	50	54	25	8.5	10.5	70
LAL5000	3/4-1	90	254	45	90	70	66	35	11	13	90

Flowing Character

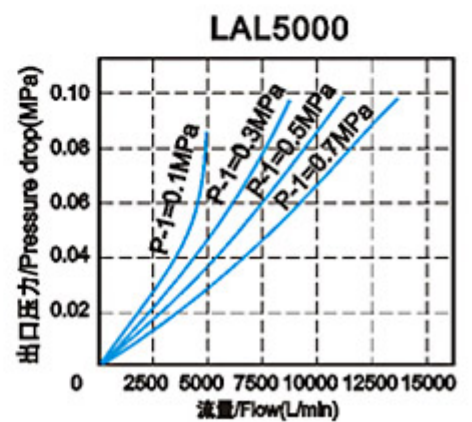
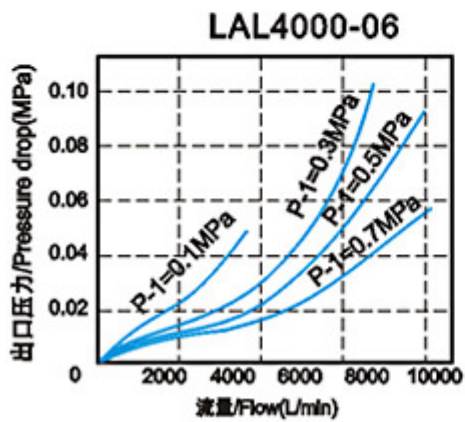
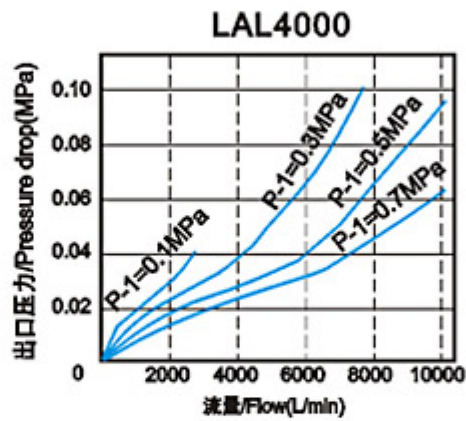
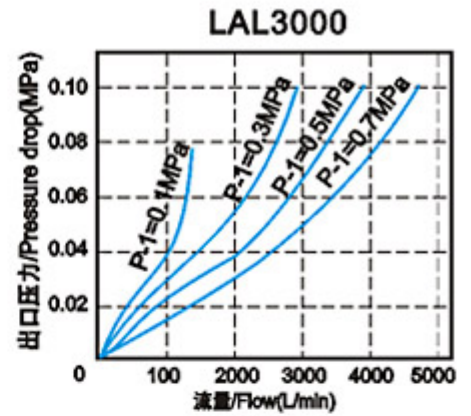
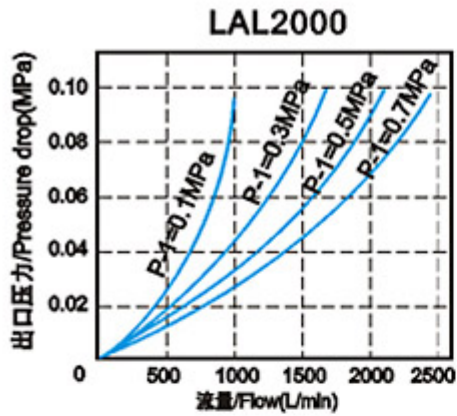

## Company Information:

**Company Name:**

Ningbo Lida Pneumatic Kit Co.,Ltd.

**Website:**<http://www.nblida.cn>

**Address:**

Eighth Quarter, Zhongxing East Road, Xikou, Fenghua, Zhejiang, China.

**Post-code:**315500

**Contact Person:**Joy Qian exporting manager

**Phone:**

**Telephone:**0086-574-88846388

**Fax:**0086-574-88846288

**Email:** export@nblida.cn